

LUCAS

TECHNICAL SERVICE

OVERSEAS TECHNICAL CORRESPONDENCE COURSE

Section 5 GENERATOR OUTPUT CONTROL



JOSEPH LUCAS (SALES & SERVICE) LTD · BIRMINGHAM 18

Printed in England



INTRODUCTION

Generator Output Control would seem to be a specialised subject of interest and value only to the Technician.

This is not altogether a fact: some knowledge of what is involved will be of great assistance to the administrator and stores operator, particularly in relation to parts ordering and stock control.

If you have followed through the generator section of this course, you will realise the important part which the control unit plays. Its combined function is to control the output over the generator speed range, regulate the current input required by the battery and when necessary provide additional current to cover the full load demand of the vehicle when lights and accessories are in use. Since this control is automatic, it is evident that the control unit is of considerable importance in the scheme of things.

An iron frame or yoke secures the voltage regulator unit and the cut-out. Although combined structurally, the regulator and cut-out are electrically separate, the regulator unit being of the electro-magnetic vibrating type. When placed in the generator circuit this unit acts as the brain of the charging system and regulates the supply of current to suit the various loads which are imposed upon it.

In order to make this unit suitable for the complete range of generators and vehicles manufactured, the load windings on the regulator are varied to suit a particular vehicle's electrical specification, i.e., type of generator, lamp and accessory load, etc. For this reason the control units are NOT interchangeable as a whole. This is an important point for administrative as well as technical personnel to keep in mind. A number of the control boxes are closely akin, and our Inter-changeability List should always be referred to by the technician and the stores manager in deciding on a suitable replacement from existing stocks, as well as helping to decide what stock should be held.

The adverse effects of fitting an incorrect replacement may not be immediately apparent. A control box with too few load turns may cause the generator to persistently overheat with consequent damage to the commutator brushes and bearings, and in extreme cases a complete burn out. The fitting of a control unit with too many load turns may cause the generator output to be insufficient to cover the load and will result in permanently run down or low charged batteries, causing premature failure of the battery through hardening of the plates.

This should be borne in mind when ordering spares, such as the regulator unit assembly where the identification number on the bracket must be reconciled to the complete unit and the vehicle concerned, otherwise the results in service can be most unsatisfactory.

Efficient performance over years of service is largely dependent upon the quality of the material used in the spring blades and bi-metal strips. Great care is taken with the specification of these materials and in the quality control of supplies coming in to the works. Also a prolonged period of running is provided on all assemblies, to normalize the springs before final adjustment of the settings. This is just another reason for buying only the original maker's genuine spares.

In view of the ever increasing demand for electric current on the modern vehicle, recent developments on generator output control have led to the introduction of the Current Voltage Control System. This is a fully proved system of control which has been applied to heavy commercial vehicles over several years and is now coming into use on the larger cars with prospects for its extension to the smaller range.

Briefly, it is a Constant Voltage Regulator with the addition of a separate Current Regulator which enables the maximum output from the generator to be available for a much longer period than if the voltage regulator only is used. By this means a discharged battery is returned to a half charged state very quickly, after which the voltage regulator takes over and proceeds with a "Tapering Charge" to completion.

Both the Compensated Voltage and Current Voltage regulating systems are fully covered in the accompanying pages of this Section.

CONTENTS

PART 1.

Why control of the generator output is necessary.

The Principles of Voltage Control.

The construction of the control unit.

Voltage control in practice — the voltage regulator.

The cutout.

A theoretical constant voltage control charging circuit.

Compensated Voltage Control.

Why compensation is necessary.

The regulator series and load windings.

The charging circuit employing the Lucas C.V.C. system.

Temperature compensation.

Auxiliary circuits — the complete control box.

PART 2.

Control Boxes : Symbols, Types and Application, Service Adjustments.

Symbols.

Features of the RF.95, 96, 97, RB.107, RB.106/1, MCRI, MCR2 control boxes.

Regulator mechanical settings contact cleaning.

Standard regulator and cut-out contacts.

The regulator points resistance.

Fuses.

PART 3.

Checking the Charging System.

Complete test procedure for the charging system, comprising battery and generator tests, checking of the regulator, electrical setting; checking cut-out operation, warning light, ammeter. Possible faults are indicated at each stage.

PART 4.

Current Voltage Regulators.

Reasons for the introduction of the current/voltage system.

Charging characteristics of the compensated voltage and current/voltage systems.

The RB.310 current-voltage regulator — build-up of the unit.

Circuits of the Lucas Current — Voltage Regulator; method of operation.

Construction details of the RB.310, 320, 300 Control Boxes.

Charging troubles — Checking and adjusting current voltage regulators.

QUESTION AND ANSWER PAPERS

STUDENT'S QUERY PAPER

AIRMAIL REPLY ENVELOPE

COPYRIGHT

*All rights reserved. No part of this
publication may be reproduced
without permission.*

JOSEPH LUCAS (SALES & SERVICE) LTD., BIRMINGHAM 18, ENGLAND.

Working Principles

GENERATOR OUTPUT CONTROL

The generators we have to deal with, you will remember, are plain, shunt-wound machines. The main characteristic of these generators is that their output rises with increasing speed. Remembering that on modern vehicles the speed at which the generator is driven may be anything between 600-6,000 r.p.m. the output could quite easily rise above the safe limits of the machine. Some control of the output is therefore necessary when our generator is applied to a vehicle as the source of the battery charging current, if it is to function efficiently at all road speeds.

APPROXIMATE BATTERY VOLTAGE: DISCHARGED 12 V.
 -- -- -- : FULLY CHARGED 16 V.

GENERATOR VOLTAGE CONTROLLED AT 16 V.

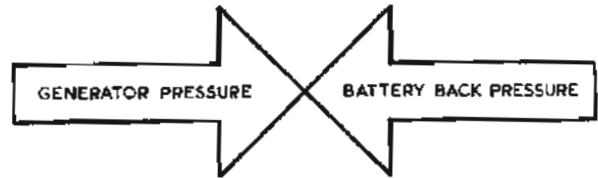

VOLTAGE CONTROL

Now on the modern vehicle how do we achieve this control of our generator output, so that at all times the battery is being correctly charged and the generator kept within its rated output? One fact really provides the key to the problem: the fact that the battery voltage varies with the state of charge. If now we could control the generator output voltage at a pre-set figure over a wide speed range, we should have a variable voltage at one end of our charging system and a constant voltage at the other. The current flowing in this charging circuit would therefore vary with the varying terminal voltage of the battery, i.e. with its

state of charge. The difference between the battery terminal voltage and the generator terminal voltage would be appreciable when the battery was in a low state of charge, getting progressively less as the battery reached its fully-charged state. If the pre-determined voltage at the generator terminals has been correctly set, in theory we shall arrive at a state where the battery terminal voltage in its fully charged condition will exactly equal the generator terminal voltage. At this point, no current will flow through the charging circuit, as the back voltage of the battery will equal the pressure or voltage of the generator.

CHARGING CHARACTERISTICS

You can see from this graph how the charging rate falls as the battery reaches its fully-charged state, becoming a trickle charge, in this case of 1 or 2 amps., after 10 hours.

It is also clear that with this system of regulation, the "Voltage Control System" as it is called, the battery receives a high charge from the generator when it most needs it.

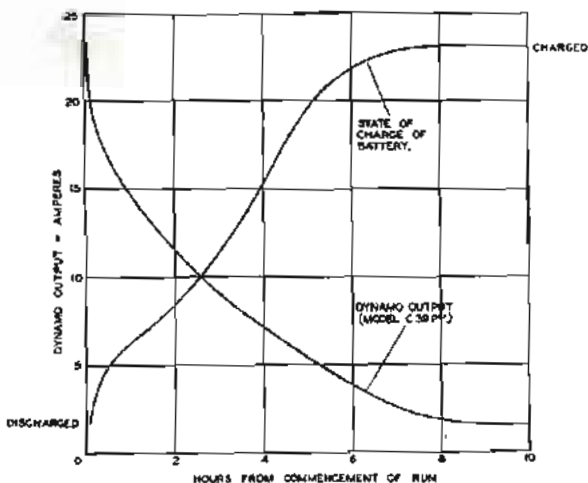

THE CONSTRUCTION OF THE CONTROL UNIT

As shown diagrammatically in this picture the Voltage Control unit comprises an Iron Frame or "Yoke" (1) on which is mounted two Iron Bobbin Cores (2) one (left) for the Voltage Regulator and the other (right) for the Cut-out Switch.

Let us consider the Voltage Regulator units; a pivoted bracket (known as an Armature) (3) is mounted by means of a Spring Blade (4) on the top of the main bracket. The horizontal member (5) lies immediately over the bobbin core and when this core is magnetised the flat member will be drawn down to it. In order to prevent it clinging to the core by residual magnetism a brass plate (6) or a copper button prevents iron to iron contact. (continued on next page.)

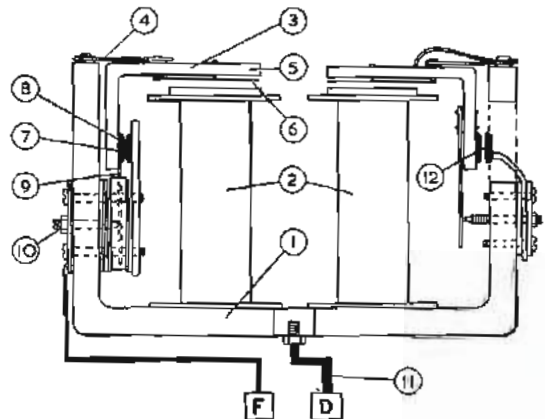

THE CONSTRUCTION OF THE CONTROL UNIT *(continued)*

On the vertical member of this "Armature" a contact point (7) is fixed to line up with a stationary contact (8) insulated from the main bracket. Also on the vertical member of the armature is a spring blade (9) and this blade lines up with an adjusting screw (10). By means of this adjusting screw the pressure between the two contact points may be varied.

The main D terminal of the generator connects to the bracket as shown (11) and the generator Field

terminal F connects to the insulated contact point (8). When at rest the two contact points will be closed, thus completing the circuit between the generator armature and field.

The contact point assembly of the automatic cut-out switch (12) is of a generally similar construction but a single opening and closing operation disconnects and connects the generator from the battery. In the normal at rest position the cut-out points are open whereas the Field Regulator points are closed.

THE GENERATOR FIELD CIRCUIT

How then, in practice, do we achieve this controlled terminal voltage at the generator. Well, you know that the output of the shunt-wound generator is only obtained when the field circuit is joined in parallel with the armature circuit, i.e. when terminals D and F are connected. If we then break this D/F connection, that is, break the field circuit, the output will immediately fall off.

Here you see the regulator frame and its connection to the generator. If you follow the circuit from the generator "D" terminal, through the right-angle frame and moving contact to the fixed contact, and back to F at the generator, you can see that D is effectively joined to F through a pair of contacts. Spring tension holds the contacts together, thus keeping the D/F circuit closed.

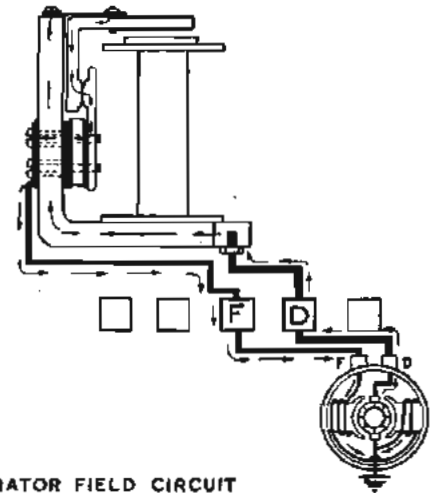

GENERATOR FIELD CIRCUIT

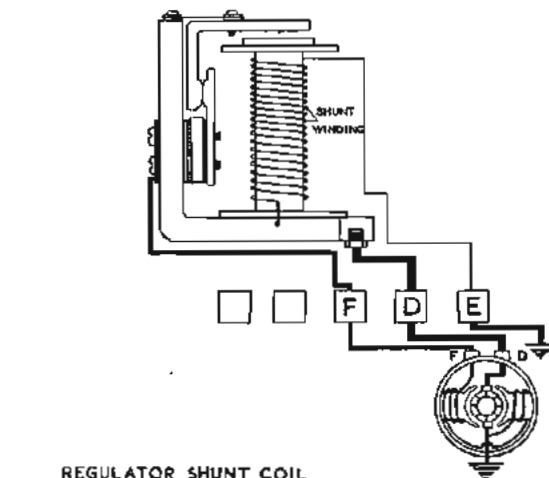

REGULATOR SHUNT COIL

REGULATOR SHUNT COIL

The breaking of the contacts is controlled by an electro-magnetic relay whose winding is connected across the generator, between terminal D and earth, that is, in parallel with the generator armature. Thus, as the generator voltage rises, this shunt winding will be energised, magnetising the core, and a point will be reached when the magnetic pull of the core is strong enough to overcome the spring tension and separate the contacts.

Immediately the contacts separate, breaking the field circuit, so the output of the generator falls. In turn, the bobbin will lose its magnetic pull, release the moving contact and, with the field circuit again completed, the generator output will rise.

When in operation this becomes an alternate rapid opening and closing of the contacts at a frequency of between 60 and 100 times per second enabling a very fine regulation of the generator voltage to be obtained.

The voltage necessary to create sufficient magnetic effect to separate the contacts can now be controlled by the spring tension on the contacts themselves. Thus we can control our generator voltage at a pre-set figure by adjustment of the spring tension. And what is more, this control is independent of the speed at which the generator is being driven, which is what we set out to achieve.

THE REGULATOR POINTS RESISTANCE

Unfortunately, however, we cannot just break a field circuit when current is passing without causing considerable sparking across the contacts. Furthermore the generator field would be slow to collapse. A resistance must therefore be placed in parallel with the contacts to protect the points against inductive surges which would occur when the contacts open at the instant when a comparatively heavy current is flowing.

When the regulator contacts are closed, then the resistance is short circuited; it provides however an alternative path between D and F when the contacts are open, thus quickly limiting the induced field current.

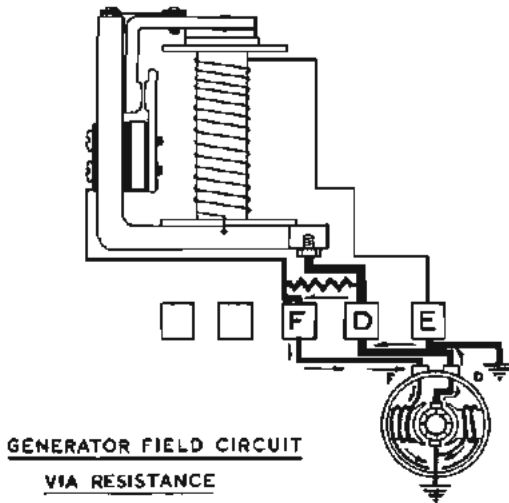

THE CHARGING CIRCUIT IN THEORY

Let us now build-up a charging circuit from what we have discussed so far. All we need is an ammeter in series with our battery, and some sort of switch to disconnect the battery from the generator when charging stops. Otherwise the battery would discharge itself through the generator windings.

We have represented this switch here by a pair of contacts on the right of the picture.

You can follow the circuit from the generator D terminal, along the extended regulator frame, through the switch and then through the ammeter to the battery. The circuit is completed via the battery and generator earths.

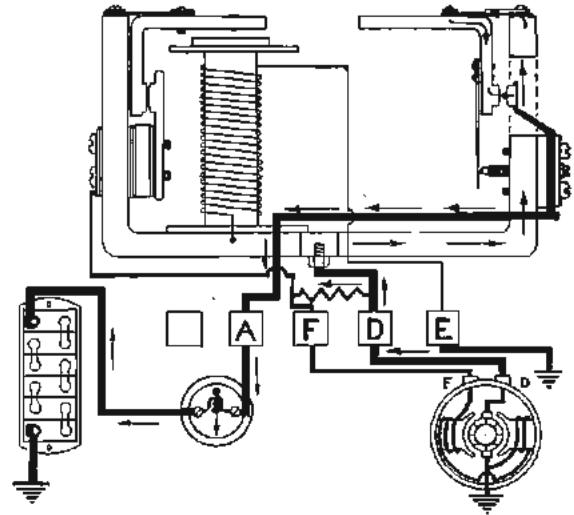

THE CUT-OUT

In practice of course all this switching is done automatically by another electro-magnetic relay called a "cut-out". The winding for this cut-out is wound on a separate bobbin for the frame and connected across the generator between terminal D and earth. It is, then, a shunt winding as was the regulator shunt winding — but we stress that the regulator and cut-out are two separate units.

You will notice that the entire regulator frame is at dynamo potential; in more practical terms, the connection from D of the generator is actually attached to the frame.

When the generator voltage rises sufficiently, the cut-out contacts are closed against spring tension by the magnetic pull from the cut-out bobbin and the circuit between the generator and the battery is thus closed.

When the generator speed is low or the engine stationary, the contacts will break, thus preventing current flowing back from the battery through the generator armature windings.

There is one important point to notice: all the charging current from the generator passes through the cut-out contacts and through a heavy "series" winding on the cut-out bobbin. This current assists

the magnetic pull of the bobbin, preventing the cut-out contacts from chattering once they have closed.

Also, when the generator stops charging, the momentary reverse current from the battery flows through this series winding, creating a magnetic flux which opposes and cancels the existing flux, and thus quickens the opening of the contacts.

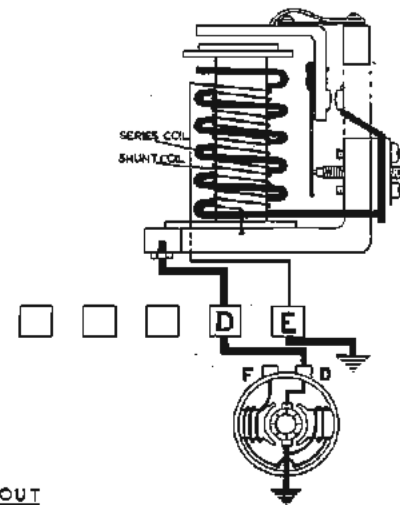

CHARGING CIRCUIT: "CONSTANT VOLTAGE CONTROL"

Our regulator and cut-out assembly, that is, our control box, would now look like this. If we follow the circuit through, starting at the D terminal of the generator, we first pass to the D terminal of the box and then to the regulator frame, through the cut-out when the contacts close, through the heavy series winding on the cut-out and across to terminal A. This terminal is connected via the ammeter to the battery. The circuit is completed by the battery and generator earths.

Unfortunately, the simple "constant voltage control" system we have built up has one snag: it presupposes the use of a generator of very great generating capacity. If we consider the case of a battery in a low state of charge, its terminal voltage will be low. If, in addition, we put a load on the battery, switch the headlamps on for instance, the voltage will fall still lower. Under such conditions, the generator will still endeavour to maintain the pre-determined voltage set by the regulator and consequently an extremely heavy current will flow in the charging circuit, owing to the substantial difference between the battery and generator potentials. In practice this current would be sufficient to burn out the armature of a standard automobile generator.

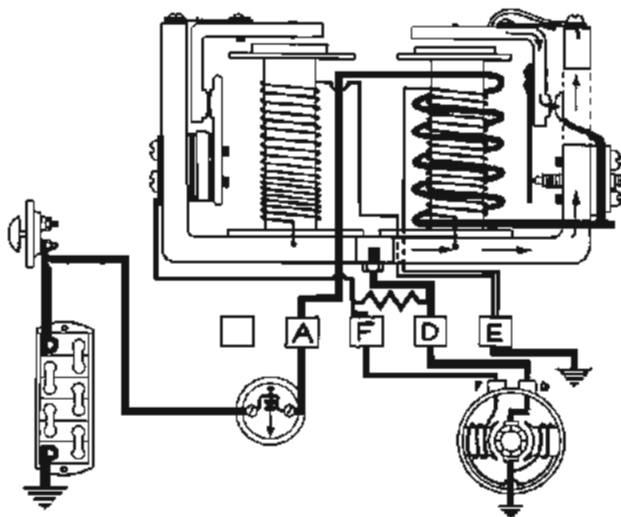

"COMPENSATED VOLTAGE CONTROL"

The Lucas "COMPENSATED Voltage Control System" overcomes this difficulty by automatically varying the OPERATIONAL voltage setting of the regulator, so that the difference between the generator and battery terminal voltages is never great enough to cause such a heavy current to flow that the generator would be damaged.

THE REGULATOR SERIES WINDING

In practice, this variation in the operating voltage of the regulator is brought about by adding another winding to the regulator bobbin. In other words, the charging circuit now continues from the cut-out series winding, not direct to terminal A, but through an additional "Series" winding on the regulator bobbin. This winding thus carries all charging current flowing from the generator to the battery and is wound so that it assists the voltage or shunt coil of the regulator in pulling apart the regulator contacts. The heavier the current flowing, the greater will be the magnetic pull of the bobbin, and the sooner the contacts will open. Thus in effect we have lowered the voltage at which regulation occurs: our generator will then be working at an operational voltage which is varied according to the current flowing into the battery.

As the battery becomes discharged and its voltage falls the charging Circuit Voltage or "LINE VOLTAGE" will also fall. The action of the COMPENSATING or SERIES winding on the regulator is thus to limit the charging current to the maximum safe output of the generator.

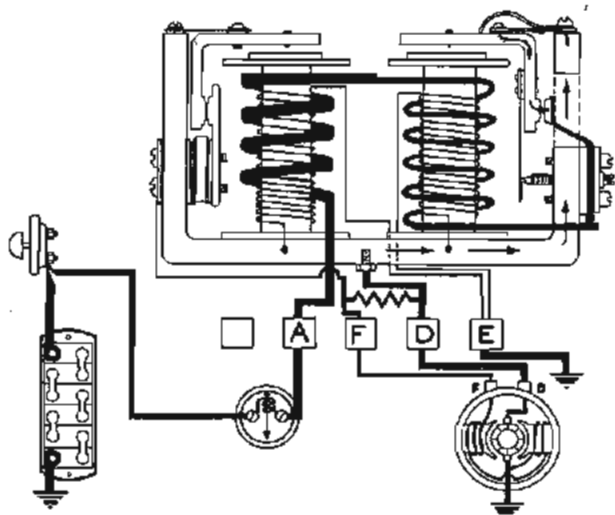

THE REGULATOR "LOAD TURNS"

If, when the battery is discharged, all the lights, etc., are switched on, a further drop in the LINE voltage will take place. To compensate for this, one or more additional turns will be added to the series winding and taken to a terminal marked A1 as shown. These are called **LOAD TURNS** and only become effective when the lights and any other external load are switched on.

In appearance all the regulator units are similar and mechanically this is so. Also with a very few exceptions the regulator settings are the same.

So, in order to make this standard unit universally applicable to all types of generators and all models of vehicles it is necessary to vary the number of turns in the compensating and load windings. The compensator windings must be made to suit the generator and the load winding to suit the external loads, that is, the lighting, etc., for different vehicle layouts.

Thus each type of control box has an identification number which relates it to the correct generator and also the vehicle application. For this reason the control units must not be interchanged except as recommended in Lucas Interchangeability Lists.

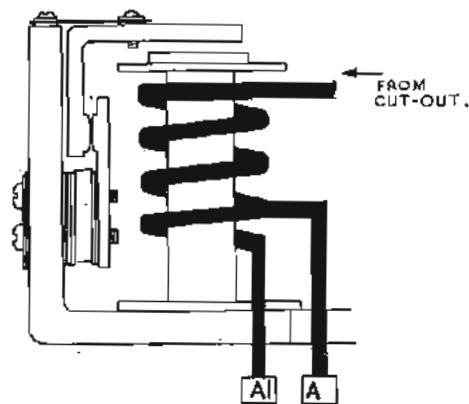

REGULATOR SPLIT SERIES WINDING

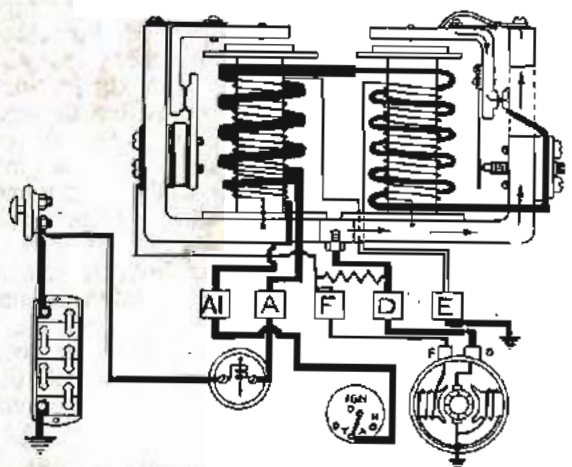

THE MAIN CHARGING AND LOAD CIRCUITS (SHOWN IN HEAVY LINES)

CHARGING CIRCUIT : COMPENSATED VOLTAGE CONTROL

We are now in a position to study the complete charging circuit incorporating a compensated voltage control regulator. Let us trace the circuit from the generator to the battery.

We will start at the generator armature which is connected to the D terminal on the generator. This terminal is connected to the D terminal at the control box and a metal connecting strip joins the D terminal to the regulator frame, causing the frame to be at generator potential. We can follow the arrows from this point. We pass along the frame, through the moving contact, then to the fixed contact when the cut-out points close. The current is then able to flow through the series winding of the cut-out and through the main regulator series winding, being taken off at the tapping to the A terminal. The circuit then continues to the battery by way of the ammeter.

The circuit is completed through the vehicle chassis and so to the earthed brush of the generator.

You can see how the current for the load circuit is taken from the very bottom of the regulator series winding to the terminal A1 and from there to the main lighting and ignition switch.

TEMPERATURE COMPENSATION

The regulators themselves, in addition to having compensating and load turns, are also TEMPERATURE compensated. This, like the regulator setting, is common to them all, but is not in any way adjustable

Put in its simplest form, this temperature compensation aims primarily to make the generator voltage-setting follow the comparative battery voltage as it rises and falls due to marked temperature changes.

As the charge proceeds, the generator will heat up quickly. The temperature compensating feature enables an extra high charge rate to be applied to the battery with a cold generator and be maintained until the generator reaches its maximum working temperature, when the generator voltage is automatically reduced by the compensator and the charge proceeds at a normal rate.

To this end, as shown in the picture, a bi-metal strip is fitted behind the contact tensioning spring. Now you know that if two strips of metal with different co-efficients of expansion are welded together and the

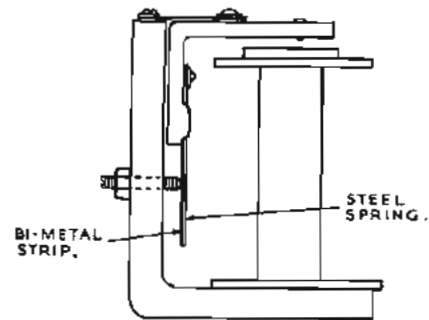

BI-METAL STRIP FITTED BEHIND CONTACT TENSIONING SPRING

combination heated, the differing degree of expansion will cause the combination to bend as the temperature rises and resumes its normal shape when the temperature falls. Having then applied such a combination of metals to the regulator adjusting spring, we can obtain a spring tension which will vary automatically with the temperature of the equipment. The controlling voltage of the regulator will thus be higher when it is cold than when it is hot.

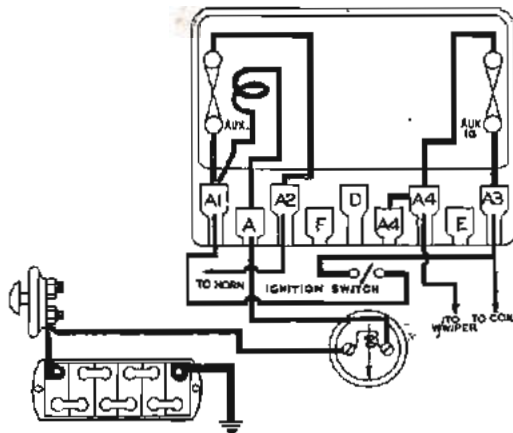

AUXILIARY IGNITION AND ACCESSORIES CIRCUIT

AUXILIARY CIRCUITS

We have now actually finished with the regulator itself, but there are other features of the control box which we must consider.

On some control boxes, additional terminals are provided to cater for accessories fitted on the vehicle, such as trafficators, windscreen wipers, etc.

Extra terminals on this type of box are, first: the A2 terminal. This, as you can see, is connected from the A1 terminal through a fuse marked "AUX" (auxiliary). Any accessories connected to this terminal will be fed from the battery via the ammeter through the load turns on the regulator bobbin, with a fuse in circuit.

Next, the A3 and A4 terminals. The A3 terminal is fed from the ignition switch, and is thus "live" only when the ignition switch is on. Both A4 terminals are then fed through a fuse from A3. Thus auxiliaries connected to A4 will only operate when the ignition is switched on. The feed to the ignition switch itself is from A1, i.e. through the LOAD turns.

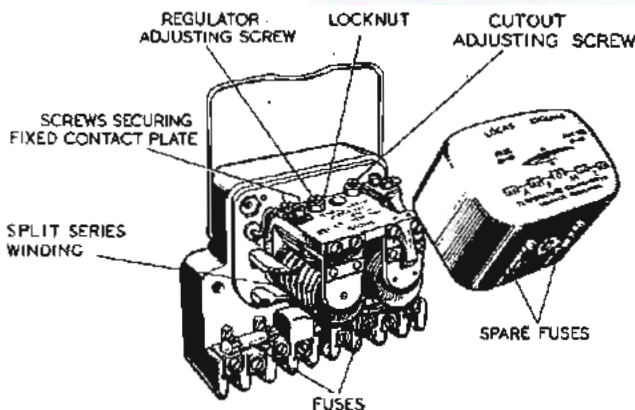

COMPENSATED VOLTAGE CONTROL REGULATOR

THE COMPLETE CONTROL BOX.

We finish this section by showing you a sketch of a complete control box.

Most of the features we have discussed are indicated. You can see the two auxiliary fuses, and the right angle bracket or yoke on which both regulator and cut-out are mounted, regulator left, cut-out right.

The regulator split-series winding is pointed out; and the screws for adjusting the spring tension on the regulator and cut-out.

Control Boxes — Symbols, Types and Application

IDENTIFICATION SYMBOLS

The symbols used for identifying the different control boxes are as follows :—

R indicates "Regulator", or "Resistance Incorporated."

F indicates "Fuse Box"

J indicates "Junction Box."

B indicates "Box."

2, 5, 7 and 9 "Type of Regulator."

1 indicates ONE Resistance.

2 indicates TWO Resistances for four pole generators.

5 indicates TWO Fuses.

6 indicates No Fuse.

7 indicates Totally enclosed "Plug-in" terminals.

X indicates partial radio suppression — may have a capacitor only.

S Full suppression, with chokes and capacitors.

RF95, 96, 97, RB107 AND RB106/1 CONTROL BOXES

We can now review the Control Boxes themselves.

We are concerned with the RF95, 96, 97 and RB107 together with RB106/1 boxes.

To begin with, what are their characteristic features? With the exception of the RB107 they all use the LRT9 regulator, with a variety of series windings, but the voltage settings are sometimes special for particular applications.

THE RF95 CONTROL BOX

This control box comprises a bakelite moulding upon which is mounted the LRT9 regulator and the cut-out assembly. The heavy series turns on the regulator are divided into the main and load compensating windings.

Two 35 amp. fuses are provided for the accessory circuits. The one fuse (right) is fed through the ignition switch. The second (left) has a direct supply through the load winding of the regulator.

The field points resistance is in the form of a cartridge placed on the underside of the base.

The terminal layout is indicated in the picture.

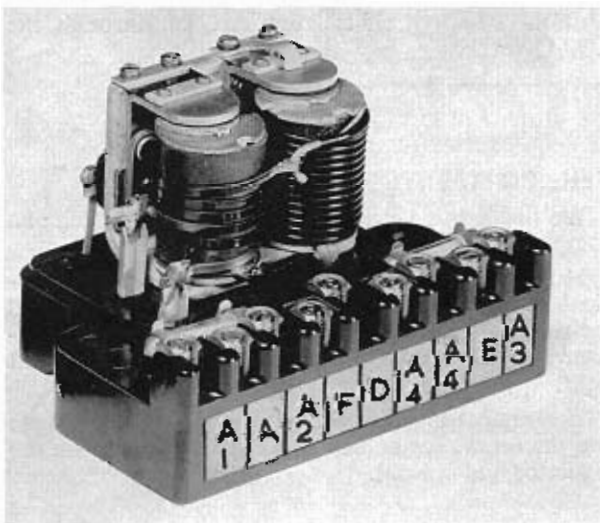

THE RF96 CONTROL BOX

This control box also has a moulded base assembly upon which is mounted a similar LRT9 regulator and cut-out. Again various split-series windings are employed.

The 96 is a more recent design than the 95 and is primarily intended for use with the heavier output generators, in particular the RA5.

The split-series winding generally has fewer turns when used with the heavier output generators.

The simplified terminal board of the box is at once noticeable.

Only terminals required by the regulator and cut-out are provided ; commencing from the left.

A1 The supply for all external load ; comes from the load turns of the split-series winding.

A Comes from the main compensating turns of the series winding.

F Wired to the generator field terminal.

D Wired to the generator main terminal.

E For the earth connection from the LRT9 assembly.

One or more independent fuse boxes can be fed from the A1 terminal according to car manufacturers' requirements.

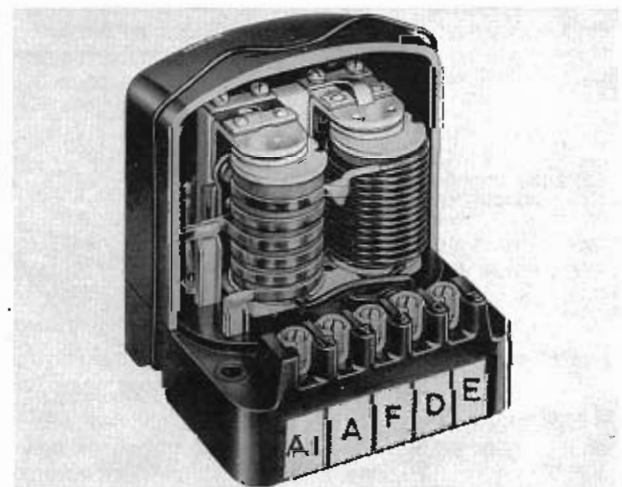

THE REGULATOR SPLIT-SERIES WINDING

You will have noticed by now that the number of series turns on the regulator bobbin varies considerably. We will sum up by saying that, generally, the higher the output rating of the generator, the fewer the series turns required. With the RA5 for instance, the high output generator used by Rolls Royce and Bentley, the regulator split-series winding has only 1 main turn, and 1 load turn.

At the other extreme, the regulator used with the fully enclosed, low output generator on the "Fordson" tractor has 6 main and three load turns.

We will stress here and now that no generator will work correctly unless it is used in conjunction with the appropriate control box.

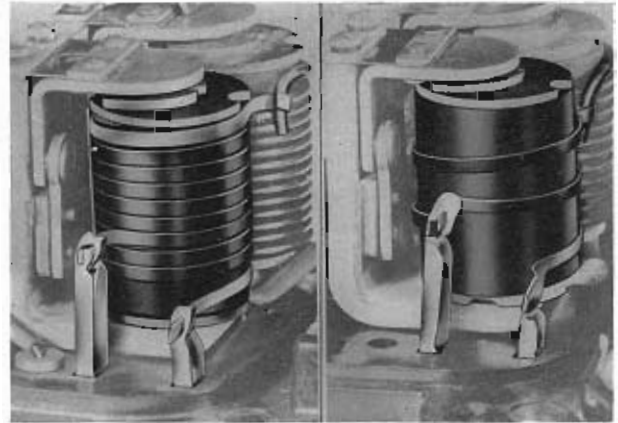

THE RF97 CONTROL BOX

This is a fully enclosed metal box assembly, designed expressly for use in exposed working conditions. It is thus well suited for marine and tractor work.

The LRT9 regulator-cut-out assembly used is fitted with a "Pellet" type resistance mounted on the back of the regulator frame and inside the box. Connections to the box are made by means of "Plug-in" terminals, thus keeping the unit watertight and dustproof.

The regulator series winding is of interest. You will notice that it is not a split winding. In other words, the box is not designed to provide compensation for a lighting and accessory load, but for use where the generator output is mostly required for charging the battery only.

The unit is sealed by means of a Langite Gasket visible in the picture and the cover is rivetted down.

In the event of it being necessary to open the box the rivets should be drilled out and the cover re-assembled and properly re-tightened by means of 2BA or similar screws and nuts.

The change from a cartridge to a pellet type resistance was introduced to enable the resistance to be

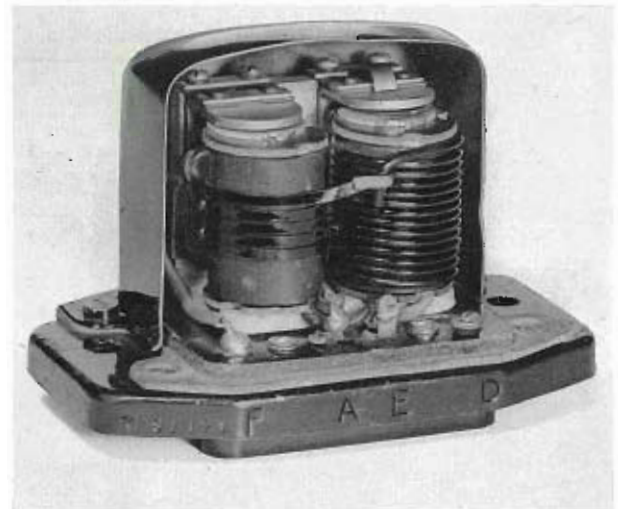

included within the sealed cover and thus prevent corrosion and damage from exposure.

The unit is produced in both 12 volt and 6 volt and mostly applied to tractors.

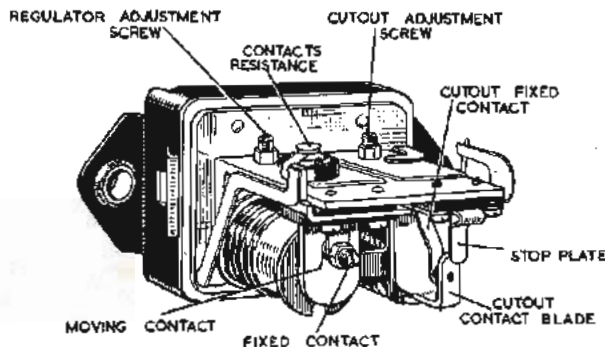

THE RB107 CONTROL BOX

This recent design of control box is a replacement for the RF97. It has been designed primarily to give greater ease of adjustment and maintenance and is now in production for fitting to tractors and motor cycles. It is specially applicable to marine work. Its electrical operation is the same as other compensated voltage control regulators.

You can see that the main constructional changes concern the cut-out and regulator contacts. Both have been redesigned and positioned above the bobbins.

THE RB106/1 CONTROL BOX

This control box is similar to the RF96, but has been designed for use with the higher output generators C45PV5 and C39PV2. It may have a series compensating winding consisting of only one main turn and one load turn.

Neither the RB106/1 nor the RF96 should be used with the lower output, fully enclosed generators, as the latter, in trying to maintain the regulation voltage with little series compensation, will be working outside their rated output and will thus over-heat.

On the other hand, if the older RF95 both with more series turns is used with the high output generators, their maximum output will never be available.

You will notice that no fuse positions are provided.

This unit is mostly used for 12 volt working but is also available for special 6 volt applications. The most recent development is the fitting of the new type regulator assembly on to the same base. This combination is known as the RB106/2.

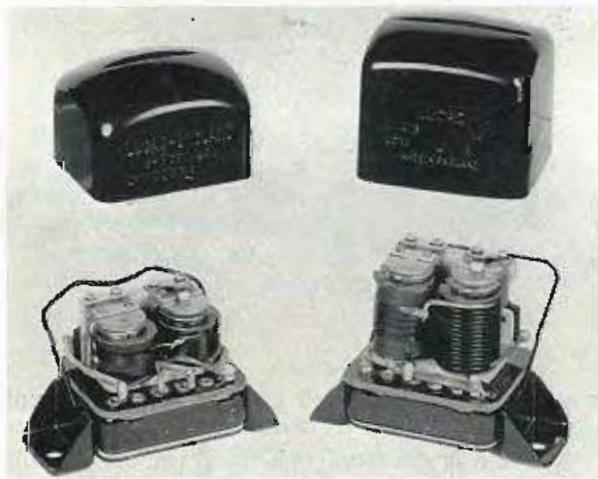
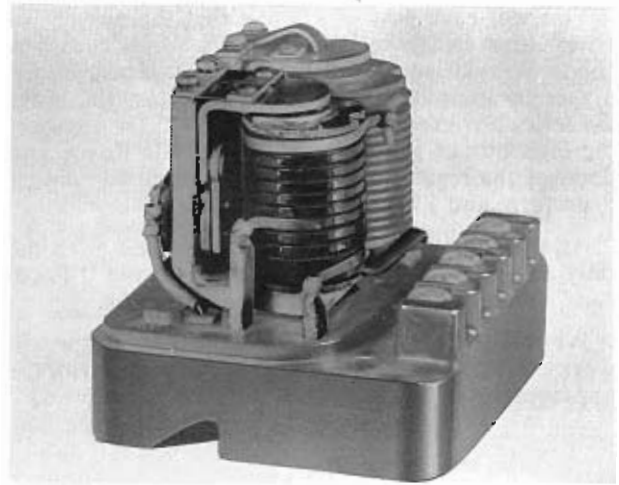

THE MCR1 AND MCR2 CONTROL BOXES

These are two motor cycle control boxes. The later model is the one on the right, the MCR2 and it has superseded the earlier MCR1 on the left.

The standard LRT9 regulator unit with Pellet resistance is fitted in the MCR2.

Do not forget that the new RB107 box is now also being used on motor cycles and is superseding both the earlier models MCR1 and MCR2.

ADJUSTMENTS IN SERVICE

There is only a limited amount of service work possible for the motor engineer who will usually require to work with the components *in situ*.

The performance of the regulator may be affected by three factors :—

(1) Maladjustment of electrical setting, usually the result of tinkering adjustments.

- (2) Oxidisation of the points due to normal usage.
- (3) Incorrect air gaps invariably due to interference.

These troubles can usually be corrected quite easily.

The voltage can be set with the aid of a good Moving Coil Voltmeter as we shall detail in the next section of this course and in the following two pictures we shall show how the air gaps can be checked and the regulator points cleaned.

Checking the Charging System

SYSTEMATIC CHECKING

In the section on generators we dealt with the electrical tests necessary for checking the machine itself. We shall now consider the whole of the charging circuit of which this forms part.

It must first be understood, however, that the circuit as a whole will not function correctly unless each of the individual units is in order, not forgetting of

course the wiring between them.

In checking for a fault on the charging system, therefore, we must proceed according to a set plan; it is no good tackling the job haphazardly. We must localise the fault to a particular section, at the same time verifying the rest of the charging circuit on the vehicle.

Let us make a start at the battery.

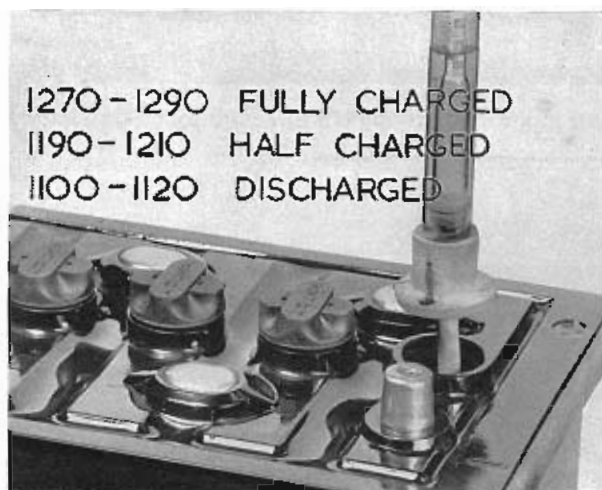

HYDROMETER TEST

We must first check the specific gravity of the electrolyte in each cell.

The Hydrometer readings for Lucas batteries are :—

1270-1290 fully charged.

1200-1210 half charged.

1100-1120 discharged.

The battery should normally be at least half-charged.

THE HEAVY DISCHARGE TEST

The hydrometer test gives us a fairly accurate account of the state of charge of each cell, but a further test must be made to make sure that the battery will supply heavy currents at the required voltage, the heavy starting currents for instance. For this purpose, we use a "heavy discharge tester" which puts an electrical load on each cell. The load, or resistance, takes at least 150 amperes from the cell in the case of a car battery, thus reproducing conditions similar to those existing when the starter motor is operated. If the hydrometer test showed the cell to be charged and if, under these test conditions, the voltage remains constant at approximately 1.5 to 1.6 volts, we can be sure the cell is serviceable. A rapidly falling voltage reading indicates a weak cell. The drop tester should be held in position for about 15 seconds per cell.

We use the same type of tester for motor cycle batteries, but a smaller load, this time of 12 amps. is adequate. A load of 300 amps. must be used for heavy commercial applications.

Having made certain that the battery is serviceable, let us now test the source of our charging current, the generator.



CHECKING THE DRIVING BELT AND GENERATOR BEARINGS

The next operation should always be to check the driving belt. After all the generator can hardly be expected to give of its best if it is not being driven correctly. There should be about half an inch movement in the belt, tested at this point. And remember that a belt that is excessively tight not only strains the generator bearings, but is also liable to damage the water pump gland. Make sure too that the belt is not frayed or oily, as this will cause slipping when the generator is under any appreciable load.

One last point, the "V" belt must not be bottoming in the pulley. If it is, either the pulley or the belt is worn. A check should also be made at this stage for side play or end float in the bearings. Make sure too that the generator leads are tight at the terminals.

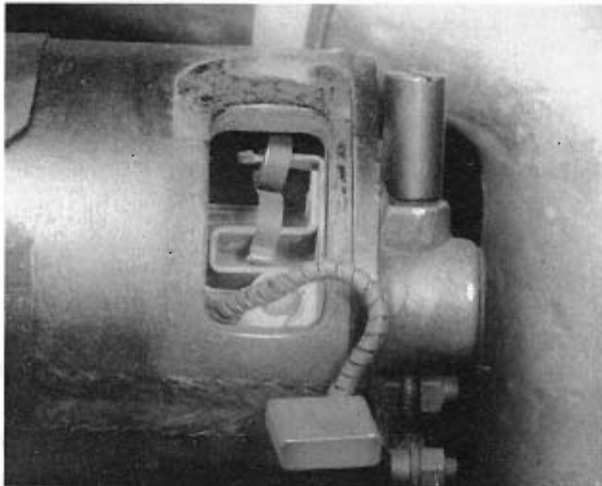
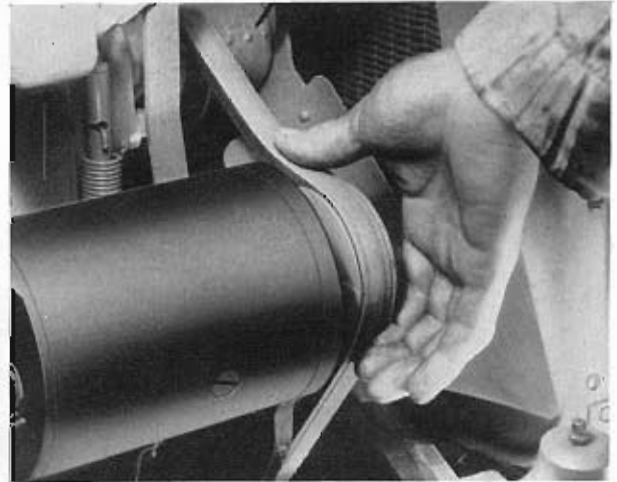

VISUAL CHECK OF BRUSHES AND COMMUTATOR

The brushes should next be checked to see that they are free in their holders and under proper spring tension.

At the same time the commutator can be inspected for glazing, roughness or overheating—the latter sometimes results in solder being thrown from the risers. The commutator surface should appear smooth but not glazed.

TESTING THE ARMATURE AND BRUSH CIRCUIT

Our first electrical test will be to see that the armature is operative and the brushes properly contacting the commutator.

The generator leads must be disconnected as you can see and a voltmeter connected between the D terminal and earth.

The engine should then be run up to charging speed approximately 1500 r.p.m. when a reading of between 2 and 3 volts should register on the voltmeter.

This reading is applicable to both 12 and 6 volt units.

The earth lead can be attached at any convenient point preferably the one shown.

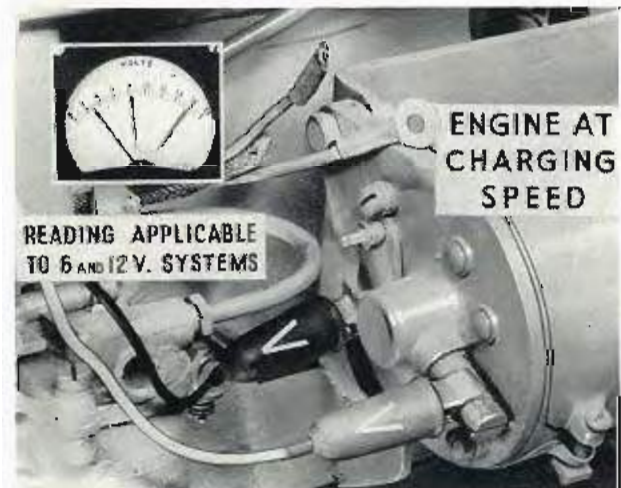

TESTING THE FIELD CIRCUIT

The next step is to ascertain that both the field coils and leads are operative and not in any way earthed, shorted or open-circuited.

Connect an ammeter between the D and F terminals still leaving the voltmeter connected as in the previous test. Increase the engine speed slowly until the reading on the voltmeter is 6 or 12 volts, i.e., the normal battery voltage of the vehicle system. At this point the ammeter should not read more than 2 amps. Our picture shows two voltmeters at the top — the one on the left reading 6 for the 6 volt system and that on the right 12 for the 12 volt system.

The ammeter reading should be the same for either system. Suppose the ammeter had registered 3 or 4 amps., instead of 2 amps. This reading could be caused by either an internal short or an earth on the field coils, which reduces the resistance of the field circuit and hence increases the current flowing in it.

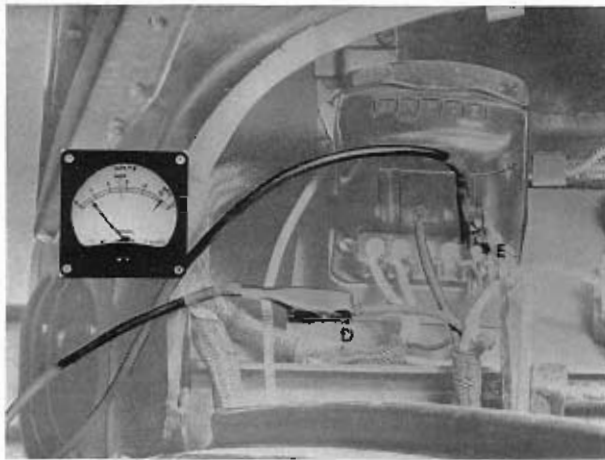
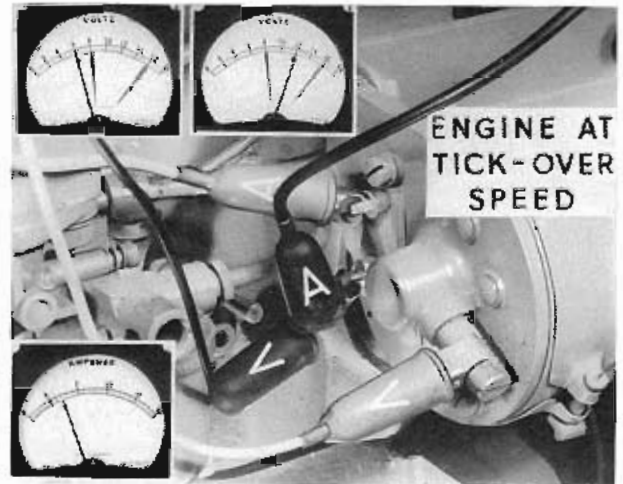

CHECKING THE GENERATOR CABLES

If the generator is in order the next step is to check the generator cables electrically, unless a complete visual examination is possible.

Repeat the last two tests to prove both the D and F cables as far as the Control Box.

First re-connect the cables at the generator and disconnect them at the control box terminals.

Our picture shows the first test, namely the voltmeter between D and earth. If there is any doubt as to which is the D and F cables, obviously this test will prove the point. Only one of the two leads should give a voltage reading — the D lead. It will record the armature voltage previously obtained, if the lead is intact.

We will take this opportunity of stressing, that if the D and F leads have been accidentally crossed, the regulator contacts will show very obvious signs of having passed excessive current. The points will be badly burnt and in some cases welded together. So be careful when re-connecting the leads.

CHECKING THE CONTROL BOX

We have now arrived at the control box, and our first check is to see if regulation is taking place.

The regulating point you will remember is the voltage at which the generator is controlled. The check must be made with the battery open-circuited. We therefore insert a piece of paper or card between the cut-out contacts. A voltmeter is then connected between earth and the regulator frame which you will remember is actually connected to the generator D terminal. Rev up the engine of the vehicle to about 1,500 r.p.m. The voltage reading will increase with rising speed, until the setting point of the regulator is reached, when there should be no further increase in voltage regardless of any normal increase in engine speed.

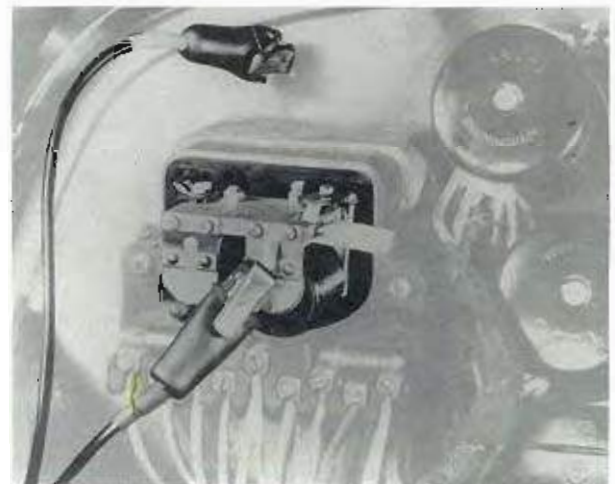

THE OPEN-CIRCUIT REGULATOR SETTING

The settings should be :—

6 volt set 7.6–8.0 volts.

12 volt set 15.6–16.2 volts.

at normal workshop temperature 68°F.

Correction must be made if prevailing temperatures are far removed from 60°–70° as shown in the accompanying table :—

	Temperature	Setting
12 volt set ...	50°F. –10°C.	15.9–16.5 volts
12 " " ..	86°F. –30°C.	15.3–15.9 "
12 " " ..	104°F. –40°C.	15.0–15.6 "
6 " " ..	50°F. –10°C.	7.7–8.1 "
6 " " ..	86°F. –30°C.	7.5–7.9 "
6 " " ..	104°F. –40°C.	7.4–7.8 "

The foregoing method of open circuiting the regulator will provide an approximate idea of the setting, but in order to get a true reading the following procedure should be adopted.

TO OPEN CIRCUIT THE CONTROL UNIT — REMOVE "A" AND "A1" LEADS

The A and A1 leads should first be removed from the terminals at the control box. This does two things : it disconnects the battery from the generator and puts the regulator load winding out of circuit. In other words, as we are only making a voltage adjustment, all we want in circuit is the voltage Regulator Shunt (Voltage-Coil). The series turns would affect the voltage setting and must be out of circuit if an accurate reading of the voltage setting is to be obtained.

The A and A1 leads will have to be twisted together after detaching from the control box terminals in order to provide a feed from the battery to the ignition coil to enable the engine to be run.

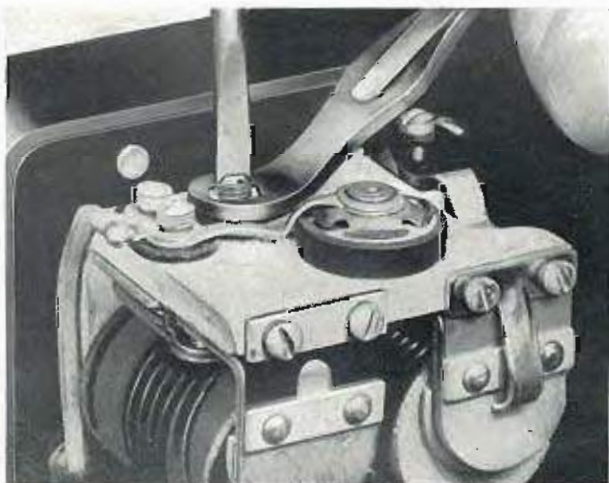
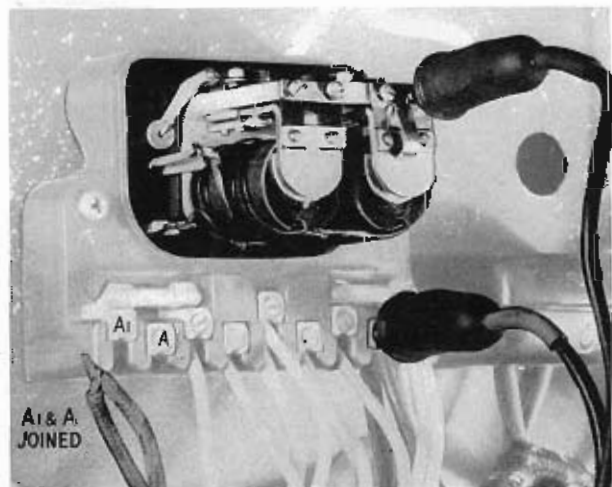

ADJUSTING THE REGULATOR SETTINGS

And now that we have put the regulator on open-circuit, its adjustment is very simple.

Run the engine at charging speed with the voltmeter already connected between regulator frame (Gen. D) and earth. Unlock the regulator adjusting screw (left) and turn inwards to increase the voltage, or outwards to lower it. On completion re-lock the adjusting screw. Reconnect A and A1 leads. Remove card from cut-out points.

Do not allow the voltage to exceed the maximum of the tolerance given in the table of settings and temperatures.

POSSIBLE FAULTS — HIGH VOLTAGE READING

If turning the adjustment screw has no effect whatsoever on the O/C voltage and the reading is right off the scale, the most likely fault is a bad control box earth — this is the fault we show in the picture.

There are two other less likely possibilities: an open-circuit regulator shunt winding or a short between the D and F terminals. In all three cases there can be no regulation of the generator voltage. Regulation, you remember, depends on the shunt winding — and one end of this is connected to the control box earth terminal. Also, if the field and dynamo terminals are shorted at any point, neither the regulator points nor the resistance can ever be in circuit to limit the generator output voltage.

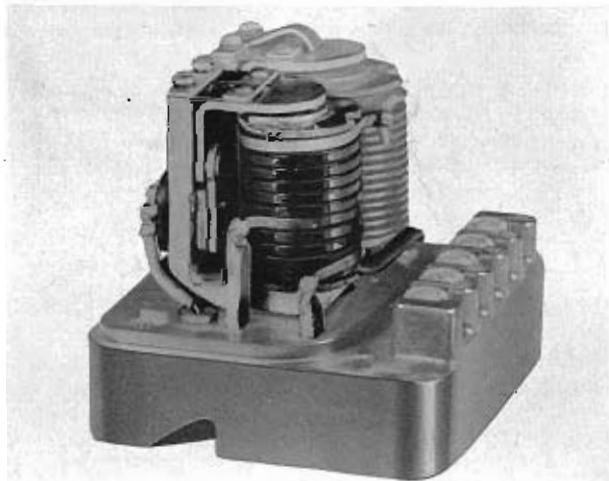
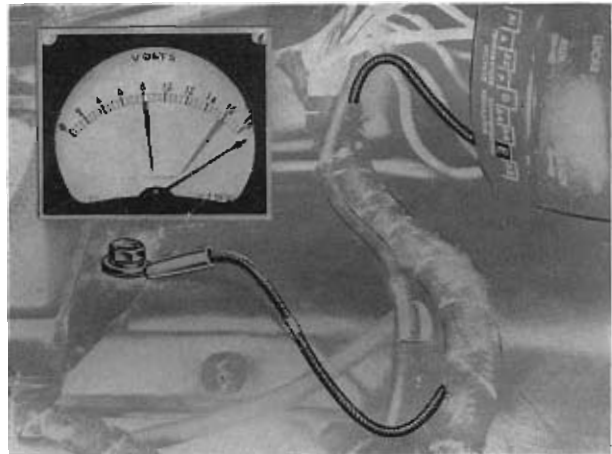

POSSIBLE FAULTS — LOW VOLTAGE READING

If on the other hand the regulator setting is found to be low and cannot be adjusted, take a look at the regulator contacts. In all probability they will be burnt and oxidised, thus making a good contact impossible and preventing the generator building-up it's normal voltage.

If the burning is obviously excessive check the resistance or examine for crossed D and F leads either at the control box or generator.

WARNING LIGHT AND AMMETER

Finally check the operation of the warning light, the ammeter and the cut-out. And do not forget the wiring behind the panel, make sure there are no loose connections or frayed leads. These can easily cause intermittent or complete failure of the charging system. The warning light for instance is connected directly to the control box D terminal and an earth on this cable would short circuit the generator output.

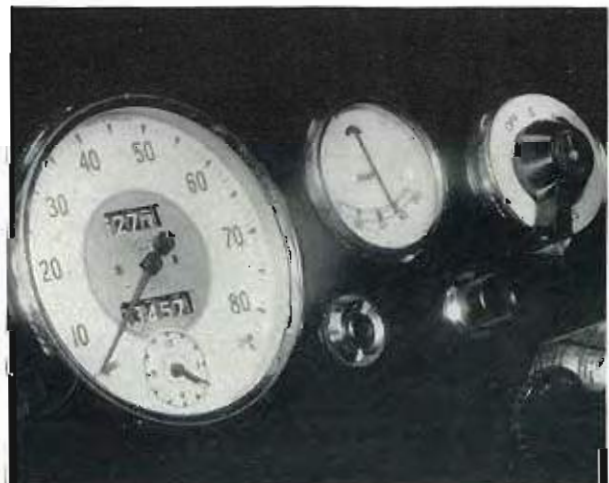

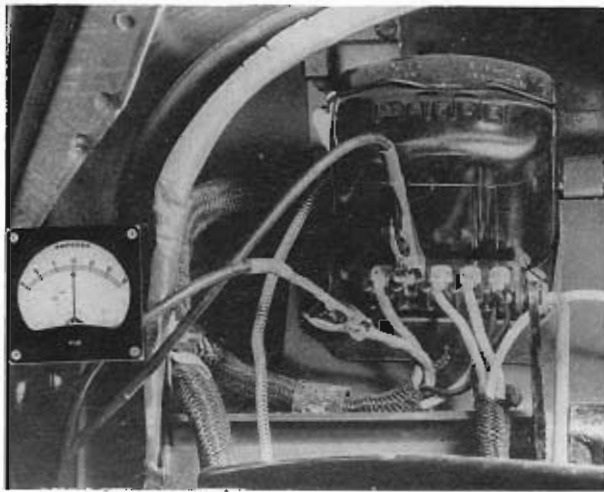

TO CHECK THE CHARGING CURRENT

If an ammeter is not fitted to the particular vehicle, the charging rate can easily be checked by connecting a test ammeter in series with the A lead. The most convenient point is at the control box.

To check the battery charging rate see that all switches are off, the charge should be approximately as shown in the guide.

Specific Gravity	Amperes
1270	5A or Lower
1250 or Lower	8A to 12 amps
1200 or Lower	15 to 17 amps

As a final check, switch on the full normal lighting load, i.e. Heads, Sides and Tail. With generator running at full charging speed the ammeter should lie between zero and approximately four amperes on the CHARGE side.

THE CHARGING CIRCUIT — COMPLETE

And just to remind you what we have been checking, here is a specimen charging circuit.

Our first checks, you will remember, were made at the battery: the hydrometer and high rate discharge tests.

We then checked the generator and the D and F cables from it to the control box. We made two tests: the first with a voltmeter between D and earth which checked the armature and brush circuit, and then we added an ammeter between the D and F terminals — to check the field current.

Then, at the control box, we checked the regulator open circuit settings. We showed you how to adjust this setting, with the A1 and A leads disconnected and joined together. We also made sure that the control box earth was good.

We then checked the operation of the cut-out and finally the warning light and ammeter. In this particular circuit, you can see there is no meter fitted. You remember too how we stressed the importance of good wiring and connections throughout the circuit.

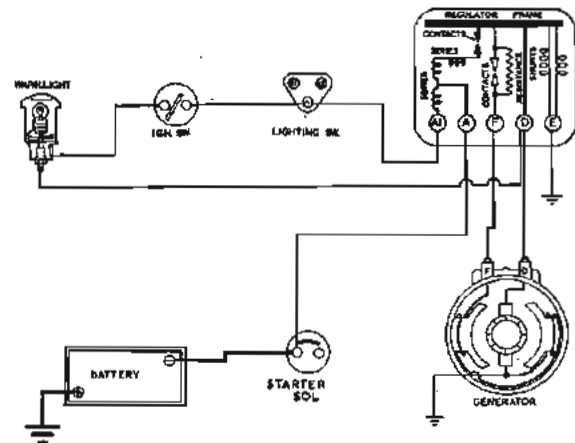

CHARGING CIRCUIT

CHECKING THE CHARGING SYSTEM

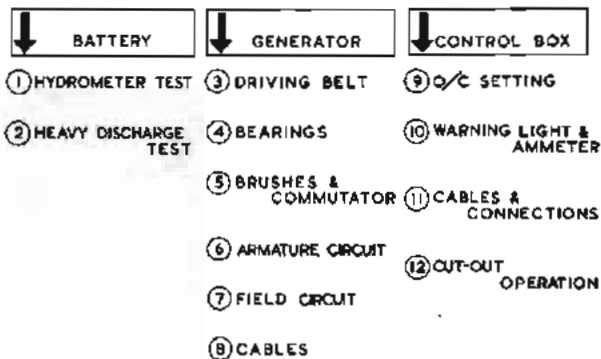

THE TEST ROUTINE

And finally, to summarise the whole business, here is a list of the operations which should be carried out in the order shown.

Current-Voltage Regulators

CURRENT-VOLTAGE CONTROL

The increasing number of electrical appliances now being fitted to the modern vehicle, many of which consume relatively heavy currents, has made necessary the introduction of a system of regulation more positive in its action than the compensated voltage system.

CHARGING CHARACTERISTICS

This graph will best illustrate what we mean. We assume our battery to be discharged. As shown by the broken line curve, with the Compensated Voltage Control System, charging commences at a relatively high rate, but quickly begins to taper off, after which, the charge steadily falls away as the battery voltage rises and finally becomes reduced to a "trickle charge."

With the Current-voltage Control System, however, the battery is charged at a uniform high rate, thanks to the *current regulator*, until the voltage of the circuit reaches a pre-determined figure, when the *voltage regulator* commences to operate and the charging current tapers off until finally only a trickle charge is delivered.

Having given you the essential differences between the two systems, let us look at one of our latest current voltage control boxes, the RB310, so that we are not attempting to explain the operation of something you may not have seen.

THE RB310 CONTROL UNIT

The complete unit consists of a normal cut-out (on the left), but has two regulators: the current regulator in the centre, and the voltage regulator on the right. It is the series-wound current regulator which controls the sustained initial charging rate and the shunt-wound voltage regulator which takes command of the system when the current flowing in the charging circuit has diminished in value.

Current-voltage control of the generator is more positive because not only is the generator output controlled at a safe maximum, but this maximum output is used to full advantage, being available if necessary for a longer period at the beginning of the charge.

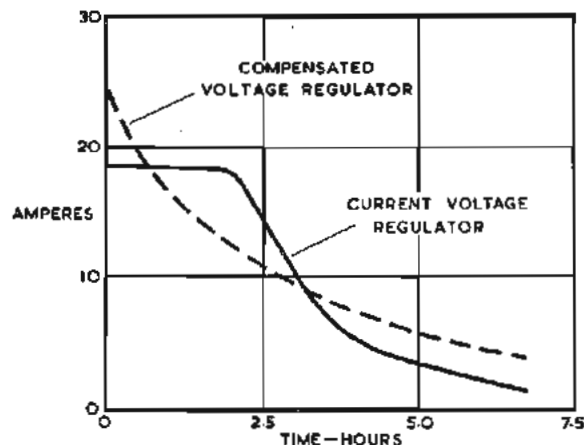

GRAPH COMPARING CHARGING CHARACTERISTICS COMMENCING WITH DISCHARGED BATTERY

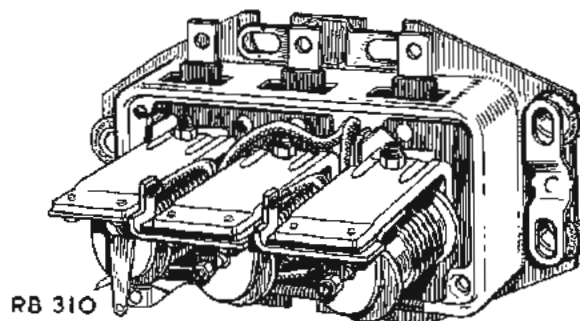

HOW THE CONTROL UNIT FUNCTIONS

This Control Box comprises three components:—

- A Cut-out Switch to connect and disconnect the generator and battery automatically.
- A Current Regulator which allows the generator to give its maximum continuous output for about one third of the time necessary to recharge a flat battery.
- A Voltage Regulator which takes over control of the output for the last two-thirds of the battery charge and thus provides a charge tapering to a finish.

Each of the items which we have mentioned has its own separate circuit in the control unit:

- The Regulator and Cut-out operating coil circuits.
- The main generator cut-out circuit.
- The Field Regulator Circuit.

We shall now study each component of the control individually after which it will be simple to follow out the overall method of operation and understand how the components combine.

First let us examine the mechanical build-up of the unit.

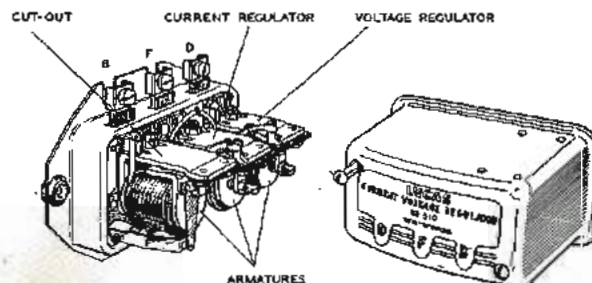

THE CONSTRUCTION OF THE CONTROL UNITS

The unit is built up from a metal base (1) upon which is fixed an insulating pad (2), mounting three iron angled frames each with an iron core (3) on which will be fixed a coil winding.

Let us first consider the Voltage and Current Regulator Units (on right and centre) which are basically similar.

A pivot angle bracket (4) — the Armature — on which is fastened one contact point is mounted by means of a spring blade (5) in metallic contact with the main frame. The horizontal member of the armature lies immediately over the bobbin core. On its vertical member a spring blade (6) is fixed downwards and coincides with an adjusting screw in the back of the frame. This armature is the moving member of the contact set. The fixed contact point is screw mounted on another and smaller bracket (7) and is also fixed to, but insulated from, the top of the main frame. By means of the setting and adjusting screws the pressure between the pair of contact points may be varied to provide the requisite voltage and current settings of the regulators.

The main D (Armature) terminal of the generator connects to the frame of the Voltage Regulator (8) and thus to the moving contact point (9). The fixed point (7) is interconnected with the fixed point of the Current Regulator (10) and the current regulator frame connects directly to the F (Field) terminal of the generator.

When at rest the two pairs of contacts will be closed thus completing the circuit between the generator

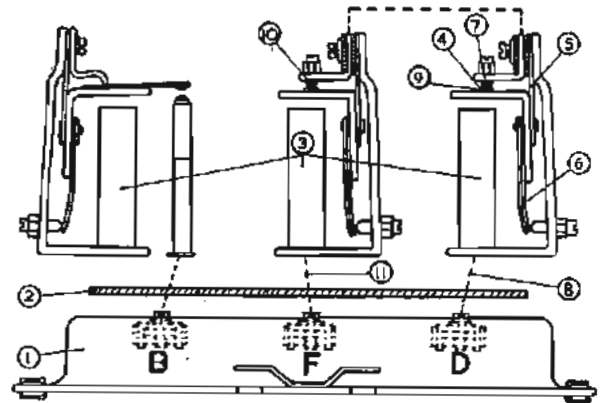

armature line and the "Field." In this condition the generator will charge, but immediately either of the contact pairs is opened by the magnetic pull from the Coil bobbins, the field circuit will be opened and the generator will cease to charge.

When in operation this becomes an alternate rapid opening and closing of the contacts at a frequency in the order of 60 to 100 times per second, enabling a very fine regulation of the generator Field to be obtained.

The contact point assembly of the automatic cut-out switch — left — is of general similar construction but a single opening and closing operation connects and disconnects the generator from the battery. In the "At Rest" position the cut-out points are open whereas both pairs of Regulator points are closed.

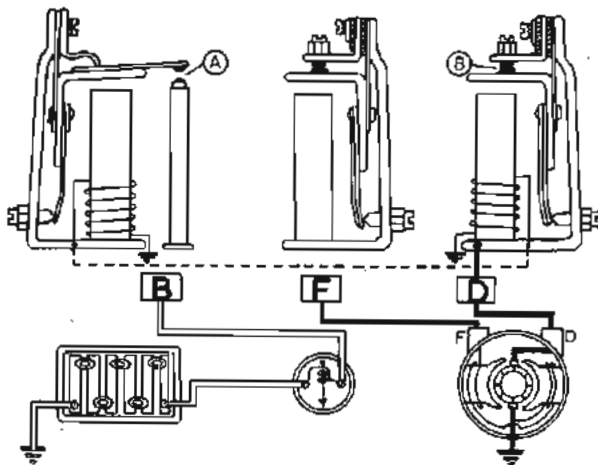

THE REGULATOR AND CUT-OUT OPERATING WINDINGS

The electro-magnetic relays which operate the cut-out switch contacts (A) and the voltage regulator contacts (B) are energised or "excited" by coils of fine enamelled wire mounted on the respective bobbins and permanently connected across the generator main circuit, i.e. "in shunt."

When the generator "builds" a sufficiently high voltage the current flowing in these windings induces a magnetic field in the cores of sufficient strength to pull down the armature and close the contact points, in the case of the cut-out, and separate them in the case of the voltage regulator.

THE GENERATOR AND CUT-OUT CIRCUIT

The current path from the generator D terminal (or armature) is taken direct to the frame of the voltage regulator unit. From there a heavy gauge copper wire is taken to the current regulator and a specified number of turns of the conductor wound around the current regulator bobbin. The conductor is then taken to the cut-out bobbin where several turns are made before it connects to the moving cut-out point. From the fixed cut-out point the conductor terminates at the terminal (B) thus completing the current path from generator to battery.

The turns of this series winding on the cut-out bobbin are wound in the same direction as the previously mentioned Shunt winding and so increase the pull, thus holding the contacts together tightly. The Shunt coil closes the cut-out points at 12.7 volts on the 12 volt system and current in the series winding holds them down.

When the generator ceases to charge and the voltage falls, these points should re-open at between 9 and 10 volts. A reverse current will commence to flow back from the battery into the generator windings. This reverse current de-magnetises the core and immediately throws the armature off, thus opening the contact points.

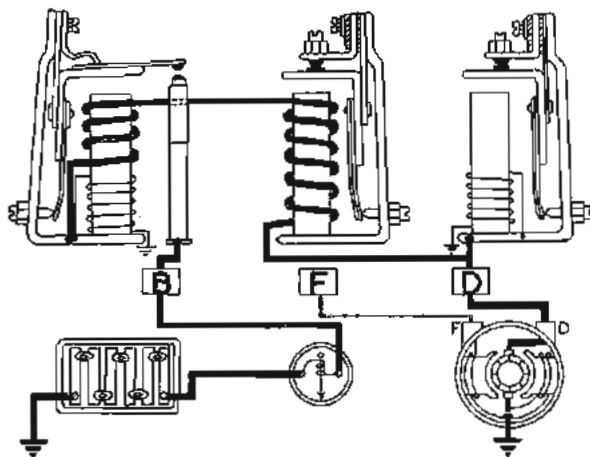

THE GENERATOR FIELD REGULATION CIRCUIT

To make the generator "build" it is necessary to connect the Field coils to the generator main circuit, i.e. connect terminal F to D.

As shown in this picture the F terminal at the generator is connected to the frame of the current regulator. From the frame we pass to the moving contact point, from the fixed contact point through a number of turns of wire on the upper part of the voltage regulator and then to the fixed contact point of the voltage regulator. We continue from the moving contact on the voltage regulator to its frame which is the generator main connection (D). Thus the field circuit is connected through two pairs of contact points "in series" and if either is opened the field circuit will be broken or "opened." When this occurs a heavy destructive flash would take place at the contact points and quickly damage them. To prevent this, a resistance is connected between D and F as shown. This provides an alternative path for the field current, but in passing through this resistance however, it is considerably weakened.

The turns of wire shown at the top of the voltage regulator bobbin — right — form what is termed a "Bucking Coil" and simply serves to steady the action between the two sets of field points.

It can now be seen that the action of the voltage regulator is controlled by the shunt coil and the bucking winding together.

The current regulator is entirely controlled by the heavy turns of wire which carry the total current from the generator.

Finally it should be observed that in the normal rest position both pairs of regulator contacts are closed; that is, the field is fully connected.

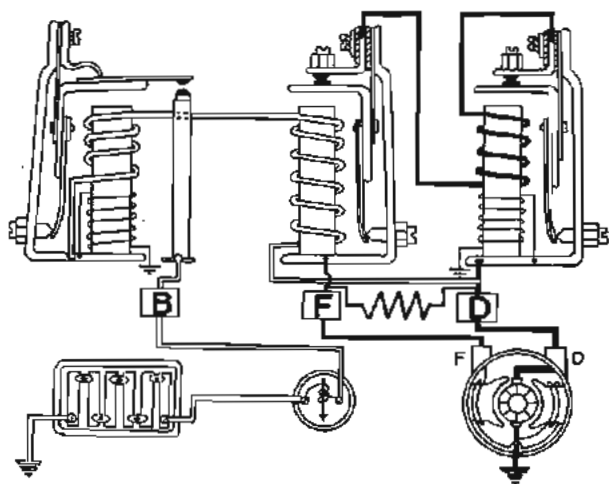

GENERAL METHOD OF OPERATION

Assuming a flat battery in circuit.

Immediately the generator is run up it builds a voltage. When this rises to 12.7 in the case of the 12 volt unit the shunt coil of the cut-out is sufficiently energised to close the cut-out points (A) against the pressure of the adjusting spring.

Current will then flow to the battery and increase directly with generator speed. By the time the generator output reaches the permissible maximum, the current regulator coil (B) is sufficiently energised to pull down the current regulator armature against its spring setting and so open the contact points, breaking the field circuit. The generator voltage then drops, the exciting current in the coil weakens and the regulator points close again allowing the voltage to rebuild. This opening and closing cycle continues at between 60 and 100 operations per second, thus limiting the total generator output to a safe maximum.

By the time the battery is something over one third fully charged its terminal voltage will have risen, resulting in a general rise in the line voltage, i.e. between generator and battery. When the line voltage reaches the correct value the voltage regulator coil (C) is sufficiently energised to pull down its armature against the spring setting. This set of field contacts will open and then be put into a state of vibration which will reduce and limit the generator voltage. As the battery, and consequently the line voltage, continues to rise, the field point vibration will

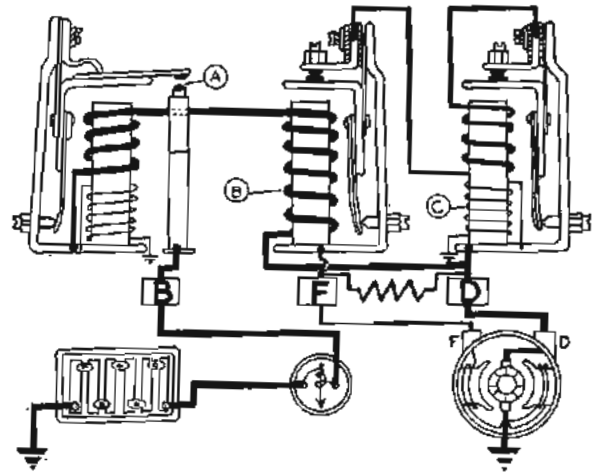

increase in amplitude and keep the generator voltage at a safe maximum.

In this condition the difference between generator and battery voltage continues to become less and the current from the generator is finally reduced to trickle charge proportions.

From the moment that the voltage regulator points come into operation, the current from the generator is so reduced that the current regulator will no longer operate, and its contact points will remain closed.

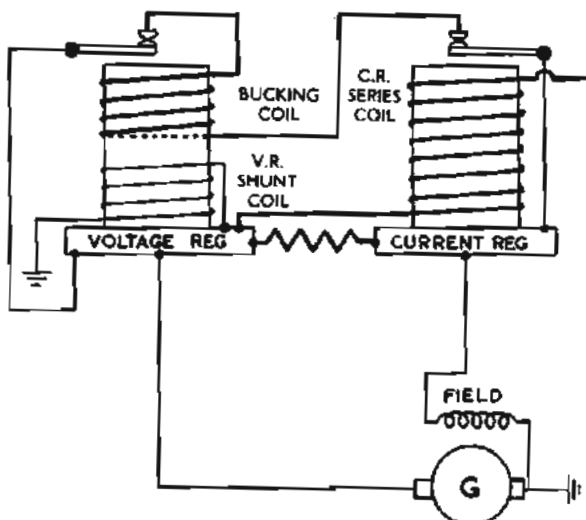

THE BUCKING COIL

The bucking coil, as you can see, is wound in series with the two sets of contacts in the field circuit. It thus passes field current. The winding consists of a few turns of thick copper wire, so wound as to assist the shunt coil of the voltage regulator. In increasing the ampere-turns of the bobbin, it therefore influences the operation of the voltage regulator contacts, quickening the break and increasing the frequency of vibration. This serves to stabilise the operation as a whole, smoothing out and steadying the generator output.

CONNECTING POINTS AND ADJUSTMENTS

Let us now examine some of the constructional details of the RB310 current-voltage regulator. The points we shall mention also apply to the RB320 which is identical in operation and very similar in construction.

The first point to note is that there are only three terminals: D, F and B, reading from left to right in the picture. The earthing of the box is done through the fixing screws to the metal base of the assembly. The fixing holes are provided with rubber cushioning.

The cut-out is temperature-compensated by means of a bi-metal strip attached to the back of the armature tensioning spring.

The voltage regulator is also temperature-compensated by means of a bi-metal strip.

The current regulator has no temperature-compensation.

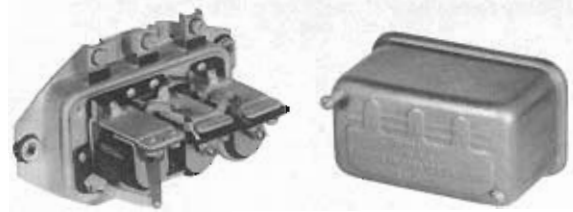

Adjustment screws for the armature tensioning springs, that is, for adjusting the electrical settings, are located in the usual position at the back of the frames.

The mechanical settings for the two regulators are controlled by adjustment screws over the tops of the bobbins.

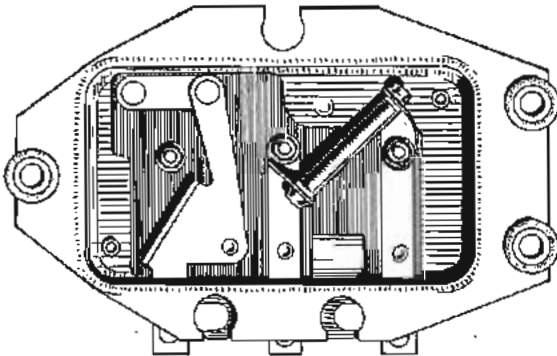

THE CONTACTS RESISTANCE

The points resistance is located under the base. It must of course be insulated from it, the latter being at earth potential.

On the 12 volt system the resistance used is a 63 ohm and on the 6 volt 50 ohms, and this rating is stamped on the body of the resistance itself.

THE RB300 CONTROL UNIT

The RB300 is a current-voltage regulator, designed especially to control 6 volt automobile generators rated at 30, 35 and 40 amperes. It is directly interchangeable with Auto-Lite or Delco-Remy units of equivalent ratings, but due to different field connections is NOT a replacement for FORD units.

It is a "multi-set" regulator, having three settings for 30, 35 or 40 amperes respectively. You can see the adjustment on the back of the current regulator.

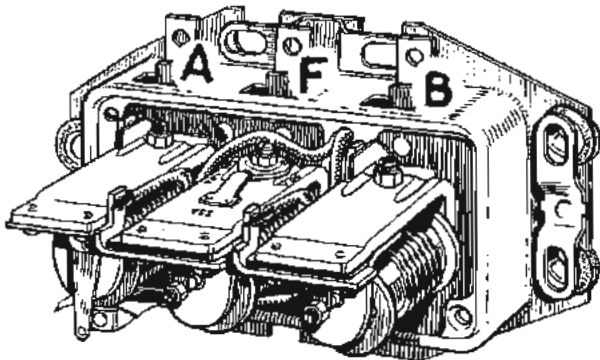

THE CURRENT ADJUSTOR

This shows you a close-up of the adjustor.

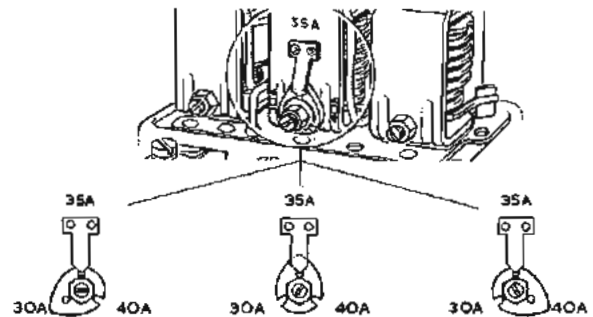

NOMINAL SETTINGS OF CURRENT REGULATOR

TERMINAL CONNECTIONS OF THE RB300

Please note the different terminal markings : " B " — battery, " F " — field, " A " — armature (i.e. normally the " D " terminal)..

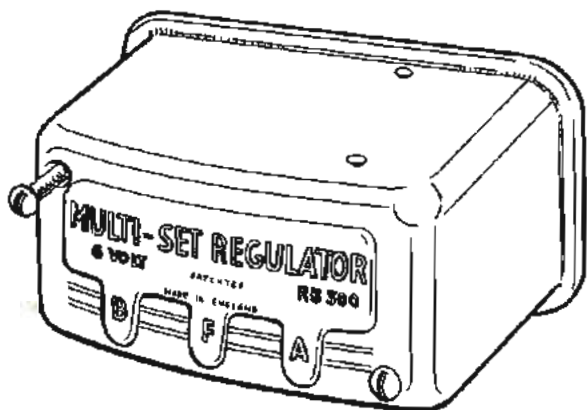

CHARGING TROUBLES

Unsatisfactory performance of the charging system will generally fall within the following categories :—

- (1) No output.
Causes : Defective generator drive. Defective generator. Defective generator wiring or control box fault.
- (2) Low output :
Causes : Defective drive, generator or control unit.
- (3) Battery continually discharged.
Causes : Defective battery. Low mileage. Defective generator drive or generator. Incorrect settings at the control unit.
- (4) High output to commence, with a quick " Fall Off."
Causes : Sulphated battery plates, or incorrect voltage regulator setting or high resistance connections on the line, particularly battery and other main earth connections.

CHECKING THE CURRENT VOLTAGE CONTROL REGULATORS

To check or adjust these units it is essential that a good quality moving coil voltmeter and ammeter should be available. It is also very necessary to see that these instruments are maintained in an accurate state.

Within our experience an extremely simple test set which may be made up, or purchased, as illustrated has been found the most satisfactory arrangement for use in the service garage.

In this set a 3½" Scale Moving Coil Ammeter calibrated 5-0-50 amperes and a similar voltmeter calibrated 0-40 volts have the correct size of very flexible leads and clips permanently connected ready for use, the assembly being accommodated in a sheet steel box with detachable cover, thus safeguarding the instruments against accidental damage in service.

Without suitable instruments NO adjustments to these control boxes should be attempted.

In every case before interfering with the Control Unit preliminary checks on the Battery, Battery Connections, Generator and Generator Driving Belt, together with an inspection of the generator and control unit cables should be made. If these are in order proceed to test, firstly the Current Regulator and secondly, the Voltage Regulator as outlined.

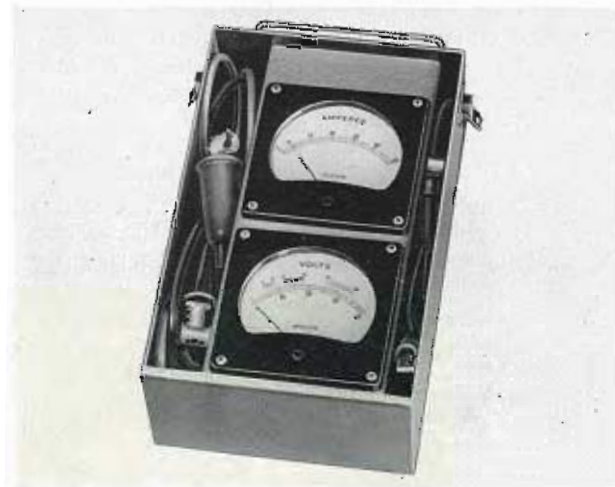

CHECK AND ADJUST THE CURRENT REGULATOR

Method 1.

Operation 1.

Place a crocodile clip across the contact plate to the frame of the Voltage Regulator as shown in the illustration to short out the voltage regulator contacts electrically.

Operation 2.

Disconnect the A (Battery) terminal at the Control Box and connect in the ammeter.

Operation 3.

Run the generator at full charging speed approximately 2,000 r.p.m.

Operation 4.

Check the current reading which should be as laid down in the table for the appropriate generator on the vehicle.

Operation 5.

If ammeter reading is either HIGH or LOW try adjustment of the Regulator.

Unlock the adjusting screw in the back plate and screw in to increase output. Unscrew to reduce output. Observe ammeter reading carefully and re-lock the adjusting screw on completion.

If O.K. rev up generator to approximately 4,000 r.p.m. and output should remain about constant.

If O.K. reduce speed to "Tick-over."

Method 2.

If a Rheostat is available capable of carrying 35 amps without overheating, proceed as follows:

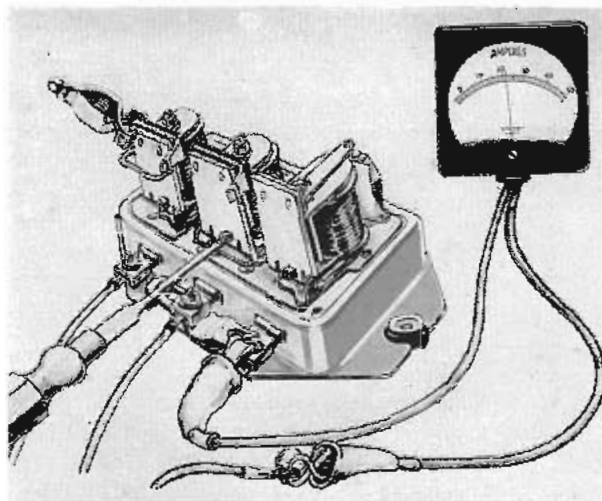

Operation 1.

Connect load Rheostat across battery terminals.

Operation 2 to 5: As above.

CURRENT REGULATOR ELECTRICAL SETTINGS

The current settings, for the standard generators, are as follows:—

6 volt	..	C45PV-5	..	33 amps.	± 1½ amps.
12 "	..	C45PV-5	..	22 "	± 1 amp.
12 "	..	C39PV-2	..	19 "	± 1 amp.
12 "	..	C47PV	..	30 "	± 1½ amps.

The RB300 current setting is 30, 35 and 40 amperes.

Note: The lights should NOT be switched on during this test with the voltage regulator shorted out and the engine running.

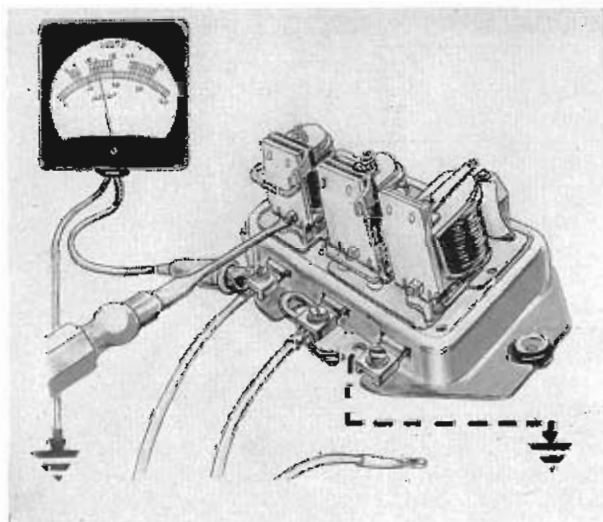

TO CHECK AND ADJUST THE VOLTAGE REGULATOR

Operation 1.

Remove the test ammeter and leave the A (Battery) lead disconnected. Also remove clip from under the regulator armature.

Operation 2.

Connect voltmeter between D terminal (Generator armature) and EARTH.

Operation 3.

Raise generator speed slowly to approximately 1,500 r.p.m. Voltage should rise and steady itself with a slight flick. According to temperature this reading should be as outlined in corresponding table for "Current-Voltage" Regulator settings.

Operation 4.

If any adjustment is required do not increase speed above 2,000 r.p.m. Unlock the unadjusting screw on the back plate of the bracket and screw inwards to increase voltage, outwards to lower the voltage. When corrected re-lock the adjusting screw. Reduce speed to "idling."

VOLTAGE REGULATOR ELECTRICAL SETTINGS

The standard Open Circuit Voltage setting with the generator running at approx. 1500 r.p.m. are as follows:—

Temperate				12 Volt	6 Volt
Cold Climate	(50°F.)	14.5—15.1 volts	7.3—7.6 volts
Temperate Climate	(68°F.)	14.2—14.8 "	7.2—7.5 "
Hot Climate	(86°F.)	13.9—14.5 "	7.1—7.4 "
Equatorial Climate	(104°F.)	13.6—14.2 "	7.0—7.3 "

7.0—7.3 volts @ 20°C. for 6 volt regulators for 'HOLDEN'

Setting or adjusting must be done as quickly as possible in order to preclude heating effects which would introduce errors into the setting.

When the generator speed is raised to 3000 r.p.m. the voltage must not rise above.

16.0 volts @ 20°C. for 12 volt regulator

8.0 volts @ 20°C. for 6 volt regulator

FINAL CHECK TEST OF THE CHARGING RATE

Leaving voltmeter connected, insert ammeter again (between terminal A (Battery)) and the "A" cable.

Steadily increase engine speed when cut-out should close at 12.7 volts and the charging rate build up with increasing speed.

Switch on full lighting load and the ammeter reading should reach the maximum rated output of the generator.

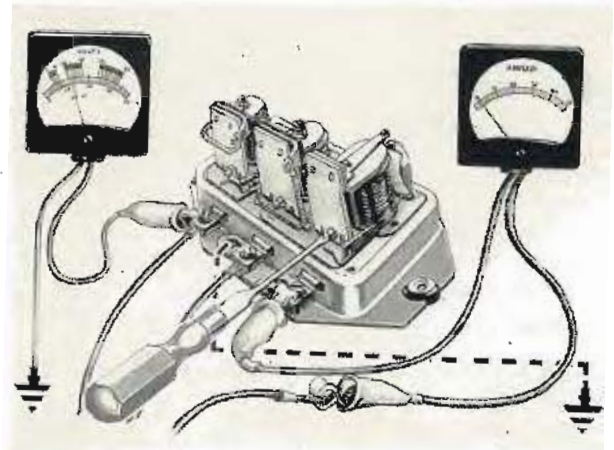

CUT-OUT SETTING

	Cut-in Voltage	Drop-off Voltage
12 volts	12.7—13.3 volts	9.5—10.5 volts
6 "	6.3—6.7 "	5.2—5.7 "

CONCLUSION

Having obtained a pretty fair idea of the various forms of generator control units and their working it may be desirable to add a note of caution.

The successful servicing of these important components does not rest entirely upon an adjustment here and there. The success of any of the servicing operations outlined depends entirely on having made

an adjustment which is stable and permanent in its subsequent working. For this reason only a limited amount of work can be successfully executed in the general garage. If the control unit, for example, will not respond to the adjustments outlined an exchange should be made and the original unit subjected to bench examination in a properly equipped electrical workshop.